



 **Wholesale Doors**

Cleary Millwork's
**COMMERCIAL
DIVISION**

THE PREMIER WHOLESALE DISTRIBUTOR OF

ARCHITECTURAL AND COMMERCIAL FLUSH WOOD DOORS,
STILE AND RAIL WOOD DOORS, HOLLOW METAL DOORS AND FRAMES,
COMMERCIAL FIBERGLASS DOORS, COMMERCIAL PREHUNG UNITS,
CONTRACT HARDWARE, TOILET PARTITIONS, WASHROOM ACCESSORIES, ACCESS PANELS.

 *Cleary*
MILLWORK

 **Wholesale Doors**
COMMERCIAL DIVISION

ABOUT US

In 2017 Wholesale Doors, based in Watertown, MA at the time, joined Cleary Millwork to become Cleary's Commercial Division. Wholesale Doors was founded in 1953 on the premise of providing a service oriented, quick ship value. Wholesale Doors has evolved to being a recognized commercial supplier to contract hardware firms and lumber dealers in New England and New York.

In 2019 the Watertown operation was moved to Somerset, MA where it merged into the existing manufacturing facility. The combination of Cleary Millwork and Wholesale Doors brings years of expertise on commercial and residential products, a greatly expanded in-stock inventory and the capacity to modify, machine, prehang and prefinish all types of doors.

As a premier wholesale distributor in the Northeast we take pride in our company and our customers in providing services and products that are unmatched by the competition.

We live by our mission statement "to provide exceptional products and services to every customer, every time".



PREFINISH YOUR DOOR WITH US

Fortress Coating Systems™ provide a superior finish on many of our products. Utilizing premium coatings from industry leading suppliers, our prime, clear, stained or painted finishes provide optimum appearance and durability.

Our Somerset facility uses an automated spray line in a state-of-the-art cleanroom spray facility. This facility specializes in finishing steel & fiberglass doors, stile and rail doors, mouldings, and stair components.

See page 21 for more information on Fortress Coating Systems™

Fortress
COATING SYSTEMS™

TABLE OF CONTENTS



HOLLOW METAL DOORS	page 4-6
HOLLOW METAL FRAMES / OTHER FRAMES	page 7-9
ADJUSTABLE FRAMES	page 10
ARCHITECTURAL FLUSH DOORS	page 11-12
COMMERCIAL FLUSH DOORS	page 13
PREFINISHING WOOD DOORS	page 14
LITES & LOUVERS	page 15
FIRE RATED STILE & RAIL DOORS AND FRAMES	page 16
STILE & RAIL WOOD DOORS	page 17
MDF DOORS	page 18
MOLDED & MDF DOORS	page 19
COMMERCIAL FIBERGLASS DOORS	page 20
PREFINISHING FIBERGLASS DOORS	page 21
HARDWARE	page 22-26
ACCESS PANELS	page 27
POCKET DOORS	page 28
BARN DOORS	page 29
TOILET PARTITIONS / WASHROOM ACCESSORIES	page 30-31



WWW.CLEARYMILLWORK.COM

Polystyrene Core



Key features

- Interior and exterior usage
- Expanded polystyrene core
- 1 3/4" door thickness standard
- Edge seam options
 - Lock seam (PA) 18 or 16-gauge
- R-Factor (metric values in parentheses)
 - ASTM C518: R7.03 (R1.24)
 - ASTM C1363: R2.44 (R0.43)
 - NFRC 102: R2.63 (R0.46)

Performance

- PA18: 1,000,000 cycles per ANSI A250.4

Fire ratings

- Available up to 3 hours

Standard features

- A40 galvanized material - primed
- 16-gauge top and bottom welded inverted channel



Standard, inverted steel channels, projection welded 16-gauge (0.056"/1.4 mm) or 14-gauge



Standard, lock seam on edge construction. Reinforced welded corners (PA).

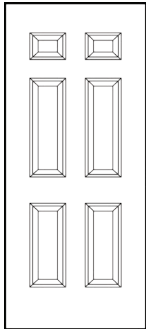

6 Panel

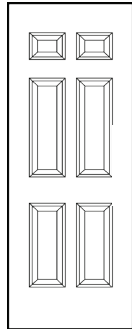

Narrow 6 panel

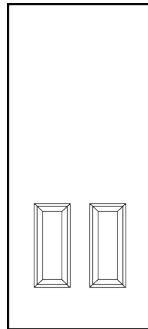

Blank top
2 panel

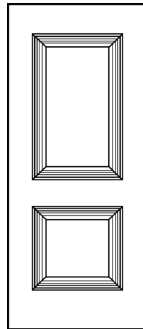

2 Panel

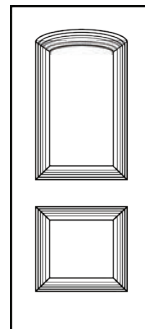

2 Panel soft
arch

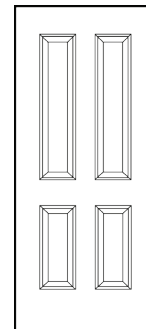

4 Panel

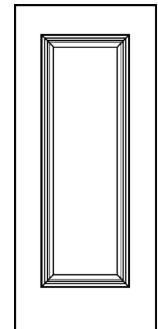

1 Panel

- 6 Panel and 2 Panel in stock 3-0 x 6-8 and 3-0 x 7-0
- 6 Panel narrow doors non stock - available in 2-8 and 2-6 wide
- All other special order - available 2-8 x 6-8 to 3-4 x 7-0



Cylindrical lock
reinforcement
12-gauge
(0.105"/ 2.7 mm) lock
front, 18-gauge
(0.044"/1.1 mm) spacer



Mortise lock
reinforcement
12-gauge
(0.105"/ 2.7 mm)
lock front, 16-gauge
(0.056"/1.4 mm) box



Flush bolt
reinforcement
12-gauge
(0.105"/ 2.7 mm)
tabs



Standard ANSI 4 7/8"
(123.8 mm) strike
reinforcement
16-gauge
(0.056"/
1.4 mm)

Economy Series Honeycomb Doors



Key features

- 1" (25.4 mm) Hexagonal cell kraft paper core
- Excellent crushing strength
- 1 3/4" Door thickness only
- Edge seam options
 - Lock seam (pa) 18-gauge

Fire ratings

- Available up to 3 hours
- Stocked with 1-1/2 hour label applied

Performance

- PA 18: 500,000 cycles per ANSI A250.4
- STC 36 (operable rating with appropriate gasketing)

Standard features

- A40 galvanized material - primed
- 16-gauge top and bottom welded inverted channel
- Square edged doors - Reversible hinge prep
- Stocked in 3-0 x 6-8 and 3-0 x 7-0
- Stocked with 161 thru-bolt prep and blank with rim reinforcement



Standard, lock seam on edge construction. Reinforced welded corners (PA)

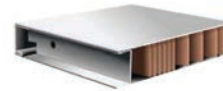

Standard, inverted steel channels, projection welded 16-gauge (0.056"/1.4 mm) or 14-gauge

HOLLOW METAL DOORS

Lite Kits And Louvers Sectional Details

Louvers sold as is. Installed in doors below in non fire rated or fire rated.

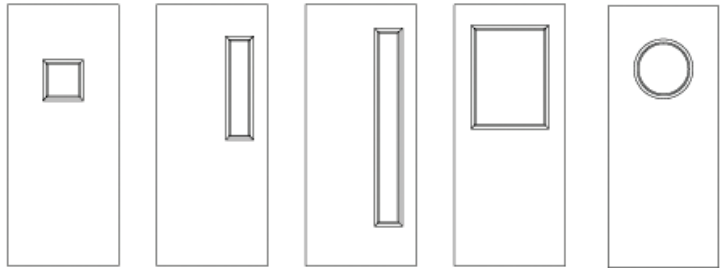

Type G Type NL Type NL-FG Type HG Type Round

Lite kits installed in doors to the left



Type G Type round Type L Type FL

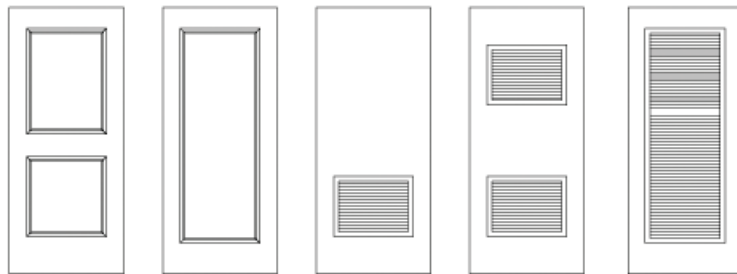

Type 2XHG Type FG Type L Type 2XL Type FL

Non fire rated

- 1/4" Clear tempered
- 5/8" Clear tempered insulated
- 1/4" Acid etched and white laminated are available special order

Fire rated

- 1/4" Safety rated wire glass
- 3/16" Clear ceramic pyran
- Other fire rated glazing products are available special order

Additional Door Products Available From De La Fontaine

Doors with Recessed Panels

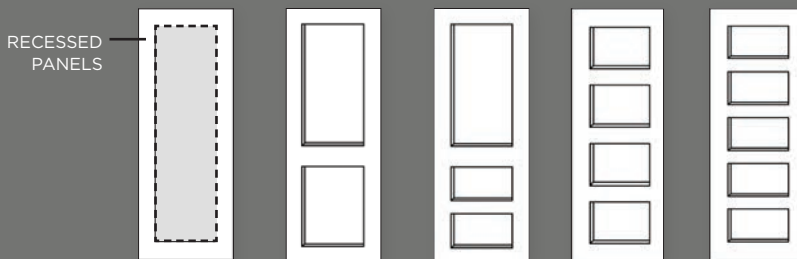

RDP 101 RDP 102 RDP 103 RDP 104 RDP 105

Doors with Inlays

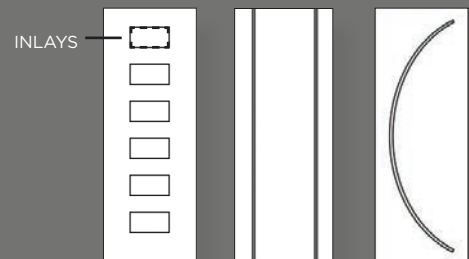

INL 101 INL 102 INL 103

Doors with Custom Embossing

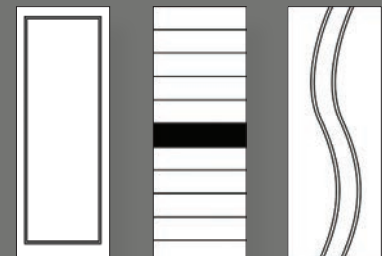
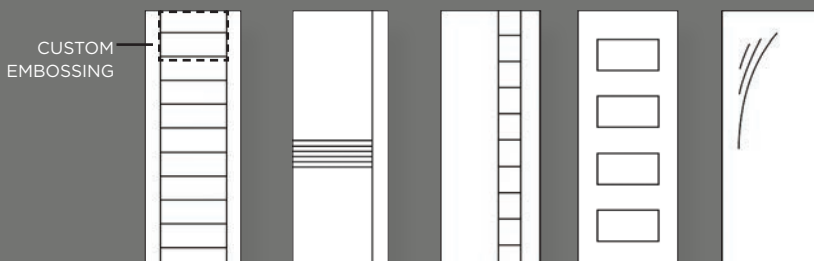

INL 104 INL 105 INL 111

Masonry

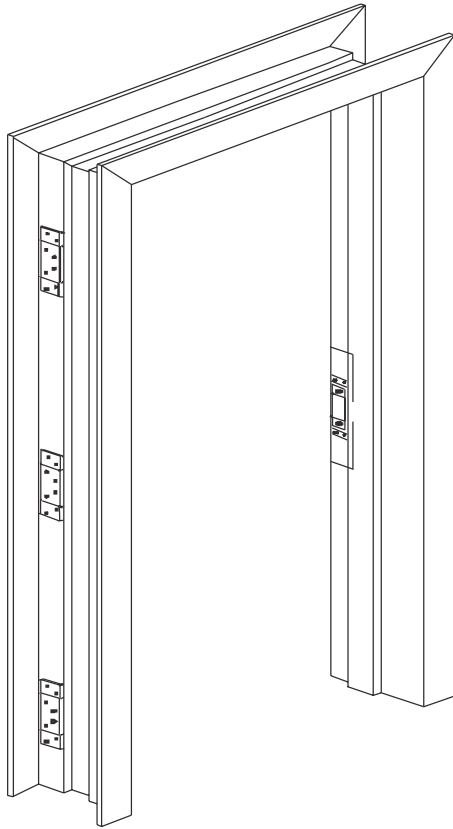

Standard frame anchors

DE LA FONTAINE standard anchors are designed for use in almost any job conditions. Custom anchors available.



"T" masonry anchor (TMA) with floor anchor, shipped loose



Wire masonry anchor (WMA), shipped loose



Existing wall anchor (EWA) with reinforcement, welded



Steel stud "Z" bracket anchor (ZBA), welded



Multi-purpose wood or steel stud anchor (SWS)

Designed to be installed in masonry wall conditions

- Available knock-down (KD)
- Face welded assembly
- Solid three-sided frame application
- Welded floor anchor and mortar guard on hinge reinforcement are standard on welded frames
- Fire rating: Up to 3 hours (ITS/WHI) fire label

Standard features

- A40 galvanized steel - primed
- 16-gauge steel

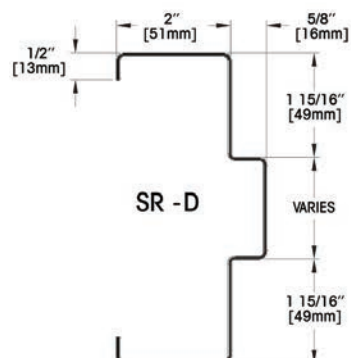

Standard frame hardware reinforcements



ANSI 4-7/8" strike reinforcement (16-gauge)



Standard (03134) or heavyweight (0.180) hinge reinforcement (10-gauge)

Masonry rough opening

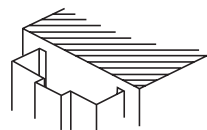

Door width + 4-1/4"
Door height + 2-1/8" for 2" head
Door height + 4-1/8" for 4" head

Drywall



DW series drywall frame

Other sizes and profiles available special order.



Screw base anchor (SBA)



Knock-down (KD) assembly with tabs and compression anchor



Steel stud "Z" bracket anchor (ZBA), welded



Multi-purpose wood or steel stud anchor (SWS)



Existing wall anchor (EWA) with reinforcement welded

Designed to be installed after the wall is up (slip-on 3-piece frame)

- Three-sided frame for drywall applications
- KD assembly
- Compression anchor (leveling screw) on each jamb for plumbness and level
- Punched and dimpled on frame face for No.6 drywall screw (standard)
- Drywall strap anchors (optional)
- Fire rating: Up to 3 hours (ITS/WHI) fire label

Standard features

- A40 galvanized steel - primed
- 16-gauge steel
- Rough opening:
 - KD Frame
 - Door width +2"
 - Door Height +1-1/4"
 - KD Cased Open Frame
 - Door Width +2-3/4"
 - Door Height +1-1/4"

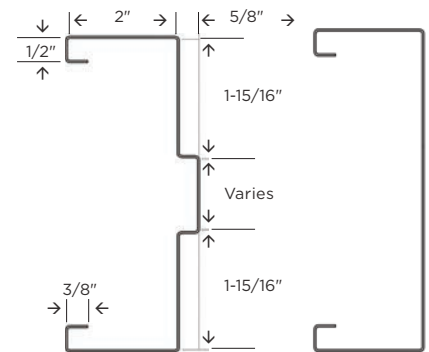

Typical elevations - Common welded frame assemblies

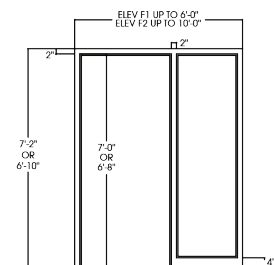
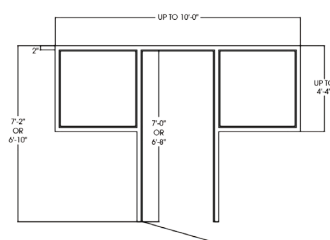
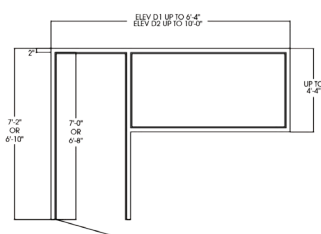
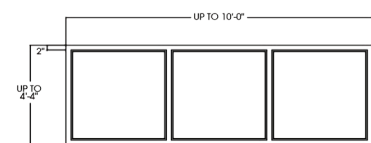
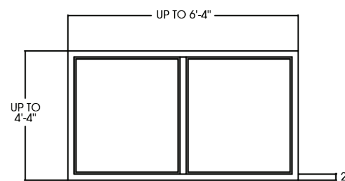
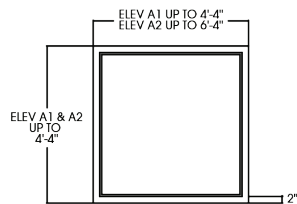

Other frame products available from De La Fontaine

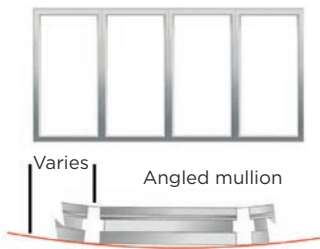

Segmented radius borrowed lite



Wood trim prep

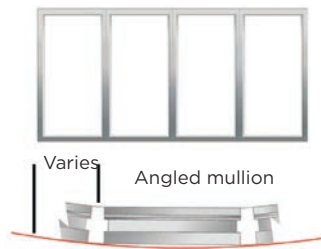

TRUE-radius borrowed lite



Split frame wrapping steel stud with drywall



Elevations - Arched Frame



Other profiles available



Single rabbet profile



Centered glass profile

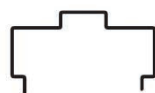

Caulking groove profile



Radius profile



Sloped sill profile

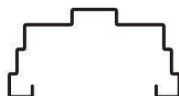

Double stepped ogee profile

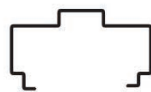

Shadow line profile

Additional frame products available on factory order

Profiles

- Less return frame with wood trim prep
- Split frame
- Other custom profiles

Elevations

- Segmented Radius Borrowed Lite
- True Radius Borrowed Lite
- Arched Frame Elevations

Materials

- A60 Galvanneal
- G90 Galvanized
- 304 & 306 Stainless Steel #4 Finish
- Factory Primed Product
- Factory Powdercoat Prefinish

ADJUSTABLE DOOR FRAMES

Rediflex Adjustable 18 Gauge Steel Frame With Steelcraft Locations

Standard unit

- 90 minute fire rating (pairs 60 minute)
- Steelcraft locations
- 4-1/2" hinge preps
- Powdercoated white
- ASA strike prep or blank strike
- 40-5/16 from bottom to lock bore
- 18 gauge frame (including closure piece)
- 10 gauge hinge reinforcement
- Weatherstripping
- Dead bolt strike prep with cover
- Dead bolt prepped at 7-11/16" on center
- Prepped for wood or metal casing
- Available with blank strike jamb
- Smooth slide system
- Installation time greatly reduced
- Quality Rediframe design

Wall thickness

6/8 and 7/0 height - 4-1/2" to 9-1/2"

Notice

Bore and lock locations at commercial height; does not line up well with typical lock rail locations on molded doors.



Fastframe Adjustable 20 Gauge Frame With Masonite Locations (Prehung)

For use with Masonite 1-3/4" steel doors below. Prehang a 20, 60, or 90 minute single door up to 3/0 x 6/8 or 7/0 in Fastframe.

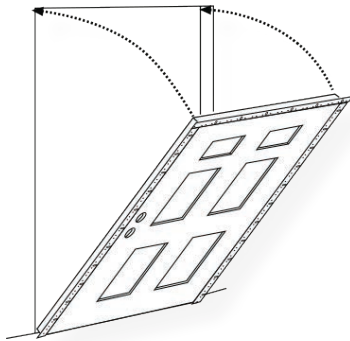

Kerf adjustable steel frame standard unit includes

- Frame: 4-1/2" - 5-1/2" kerfed adjustable steel 90 minute
- Hinges: 1-1/2 Pair 4 x 4 satin brass spring hinges
- Bore: Specify single bore (2-3/8" or 2-3/4" backset)
Extender kit, white weatherstrip and hardware shipped loose

Rough opening

- Door size + 1-1/4" width, 1" height - ADA sill
- Door size + 1-1/4" width, 1-1/2" height - high dam sill



1-3/4" Steel doors

90 minute fire door entry system hung in steel frame.

• 3'0 x 6'8 & 7'0" also stocked with closer and panic reinforcement. Please specify if required.

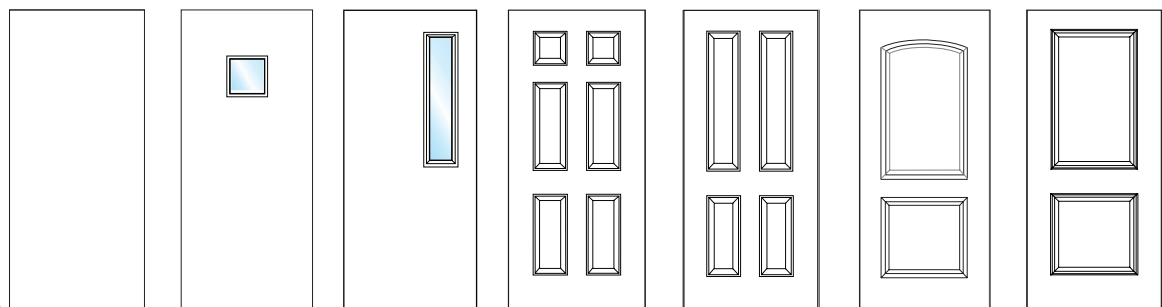

	Flush 90R	Flush 1090R	Flush 590R	6 Panel 90R	4 Panel New England 90R	2 Panel Camber-top	2 Panel Square-top
3/0 X 6/8	X•	X•	X•	X•	X•	X	X
2/10 X 6/8	-	-	-	X	-	-	-
2/8 X 6/8	X	X	X	X	X	X	X
2/6 X 6/8	X	X	X	X	-	-	-
2/0 X 6/8	X	X	X	-	-	-	-
3/0 X 7/0	X	X	X	X	-	-	-

Architectural Flush Wood Doors

Architectural flush wood doors in stock

- Matching edge
- Bonded core construction
- Hot pressed faces, 1/50" veneer thickness
- Meet WDMA I.S-1A premium grade
- Face veneers meet WDMA "A" grade ("AA" grade available on special factory order)
- Limited lifetime warranty
- Doors are built to meet or exceed industry performance requirements

HEAVY DUTY PARTICLE CORE (PC)

Stock veneers (book and running match unless noted)
other veneers and configurations available on special factory order

PARTICLE CORE	ROTARY CUT WHITE BIRCH	ROTARY CUT NATURAL BIRCH	PLAIN SLICED WHITE BIRCH	PLAIN SLICED RED OAK	PLAIN SLICED WHITE OAK	RIFT CUT RED OAK slip match	PLAIN SLICED WHITE MAPLE	PLAIN SLICED CHERRY	FLAT CUT AFRICAN MAHOGANY	PLAIN SLICED WALNUT	PRIMED MDO
3/0 X 6/8	X			X							
2/0 X 7/0	X, Y			X			X		X		
2/6 X 7/0	X, Y			X	X		X	X	X		
2/8 X 7/0	X			X			X	X	X		X
3/0 X 7/0	X, Y	X	X	X, Y	X	X	X, Y	X, Y	X, Y	X	X
3/6 X 7/0	X			X			X	X			X
3/8 X 7/0	X			X							
4/0 X 7/0	X			X			X	X	X		
2/0 X 8/0	X			X							
2/6 X 8/0	X			X							
3/0 X 8/0	X, Y			X, Y	X	X	X, Y	X, Y	X, Y	X	
3/6 X 8/0	X			X							
4/0 X 8/0	X			X			X				
3/0 X 9/0	X	X	X	X	X		X, Y	X, Y	X, Y		
4/0 X 9/0	X	X	X	X		X	X	X	X		



X= STANDARD DOOR Y = TRUE PAIR MATCHED DOOR

EXTRA HEAVY DUTY STRUCTURAL COMPOSITE LUMBER CORE (SCL)

*Retains warranty with full lite cutout

Stock veneers (book and running match unless noted)
other veneers and configurations available on special factory order

	ROTARY CUT WHITE BIRCH	PLAIN SLICED RED OAK	PLAIN SLICED WHITE MAPLE	PLAIN SLICED CHERRY	FLAT CUT AFRICAN MAHOGANY	PLAIN SLICED WHITE BIRCH	PRIMED MDO
3/0 x 7/0	J, K	J, K	J, K	J, K	J, K	J, K	J, K
4/0 x 7/0	J, K	J, K	J, K				
3/0 x 9/0	J	J	J	J	J	J	J

J= STANDARD DOOR K= SCL CORE - CAN BE 45 MINUTE FIRE RATED - SINGLE DOOR ONLY

Doors can be machined, prefinished (stain or paint), re-sized, glazed, prehung in our shop



Architectural Flush Wood Doors



FIRE PROTECTIVE MINERAL CORE (MC)										
45-90 minute fire rating. Mineral core doors can be neutral pressure or category B positive pressure										
Stock veneers (book and running match unless noted) other veneers and configurations available on special factory order										
	ROTARY CUT WHITE BIRCH	ROTA- RY CUT NATURAL BIRCH	PLAIN SLICED WHITE BIRCH	PLAIN SLICED RED OAK	PLAIN SLICED WHITE OAK	RIFT CUT RED OAK slip match	PLAIN SLICED WHITE MAPLE	PLAIN SLICED CHERRY	FLAT CUT AFRICAN MA-HOGANY	PRIMED MDO
2/0 x 6/8		A								
2/4 x 6/8		A								
2/6 x 6/8		A								
2/8 x 6/8		A								
2/10 x 6/8		A								
3/0 x 6/8	A, B, C	A, B, C		A, C						
3/6 x 6/8	C	A		C						
3/8 x 6/8	C	A								
4/0 x 6/8	C	A								
2/0 x 7/0	A	A		A						
2/6 x 7/0	A	A		A						
2/8 x 7/0		A		A						
2/10 x 7/0		A		A						
3/0 x 7/0	A, B, C	A, B, C	C	A, B, C	C	C	A, B, C	A, B, C	A, C	A
3/4 x 7/0		A								
3/6 x 7/0	C	A		C						
3/8 x 7/0	C	A		C						
4/0 x 7/0	C	A		C			C		C	
3/0 x 8/0	C	A		C	C		A, B, C	B, C	B,C	
4/0 x 8/0							C	C	C	
3/0 x 9/0	C			C						
4/0 x 9/0	C			C		C				

A= STANDARD DOOR

B=TRUE PAIR MATCH - CLOSER BLOCKED

C= STANDARD DOOR - CLOSER BLOCKED

LEAD LINED CORE - 1/16" LEAD		
RADIATION PROTECTION - LEAD LINED CORE - 1/16" LEAD		
	ROTARY CUT WHITE BIRCH	PLAIN SLICED RED OAK
3/0 x 7/0	X	X
3/8 x 7/0	X	X
4/0 x 7/0	X	X

Commercial Flush Wood Doors

Commercial flush wood doors in stock

- Economical alternative to architectural grade doors
- Natural & White Birch commercial doors have compatible aspen edges
- Red oak commercial doors are matching edge
- Bonded core construction

Economy flush wood doors in stock

- Natural Birch doors have veneered edges
- Natural Birch doors are stocked in unfinished and clear prefinished
- Hardboard doors are primed
- Non bonded construction

PARTICLE CORE	COMMERCIAL NATURAL BIRCH	COMMERCIAL WHITE BIRCH	COMMERCIAL RED OAK	ECONOMY NATURAL BIRCH	ECONOMY NATURAL BIRCH CLEAR PF	PRIMED HARDBOARD
1/0 x 6/8	X					
1/3 x 6/8	X					
1/6 x 6/8	X					
2/0 x 6/8	X		X			
2/2 x 6/8	X					
2/4 x 6/8	X					
2/6 x 6/8	X		X			X
2/8 x 6/8	X					X
2/10 x 6/8	X					
3/0 x 6/8	X, Y	X	X	X	X	X
3/4 x 6/8	X					
3/6 x 6/8	X		X			
3/8 x 6/8	X					
4/0 x 6/8	X					
1/0 x 7/0	X					
1/3 x 7/0	X					
1/6 x 7/0	X					
2/0 x 7/0	X	X	X			X
2/2 x 7/0	X					
2/4 x 7/0	X		X			
2/6 x 7/0	X	X	X			X
2/8 x 7/0	X	X	X			X
2/10 x 7/0	X	X	X			X
3/0 x 7/0	X, Y	X	X	X	X	X
3/4 x 7/0	X					
3/6 x 7/0	X	X	X			X
3/8 x 7/0	X	X				
4/0 x 7/0	X	X	X			X
2/0 x 8/0	X					
2/6 x 8/0	X					
3/0 x 8/0	X	X			X	X
3/6 x 8/0	X					X
4/0 x 8/0	X					X
3/0 x 9/0						X



Y=TRUE PAIR MATCHED DOOR X= STANDARD DOOR

Fire rated doors

FIRE PROTECTIVE MINERAL CORE (MC) 45-90 Minute fire rating. Mineral core doors can be neutral pressure or category B positive pressure		
MINERAL CORE	COMMERCIAL WHITE BIRCH	PRIMED HARDBOARD
3/0 x 6/8	X, Y	X
3/0 x 7/0	X, Y	X

X= STANDARD DOOR Y= TRUE PAIR MATCHED DOOR

See architectural section for all other mineral core fire doors

Fortress Coating Systems™

Fortress Coating Systems™ provide a superior finish on many of our products. Utilizing premium coatings from industry leading suppliers, our prime, clear, stained or painted finishes provide optimum appearance and durability.



NATURAL BIRCH SHOWN

Please note the stain color samples below are not an exact match. Refer to our Fortress Coating Systems™ Color Sample Catalogs for available stain and paint finishes.

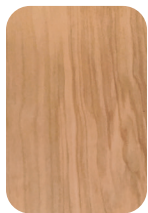

CLEAR



WD-1 HONEY



WD-2 AUTUMN



WD-3 CINNAMON



WD-4 NUTMEG



WD-5 TOAST



WD-6 AMBER



WD-7 SAFFRON



WD-8 MERLOT



WD-9 TEAK



WD-10 RED



WD-11 MAHOGANY



WD-12 WALNUT



WD-13 BROWN



WD-14 DARK BROWN

Available Color Sample Brochures



Stain & color samples for commercial doors



Stain & paint samples for
Exterior Fiberglass and Wood Doors

LITES AND LOUVERS

Metal Lites And Louvers For Flush Doors

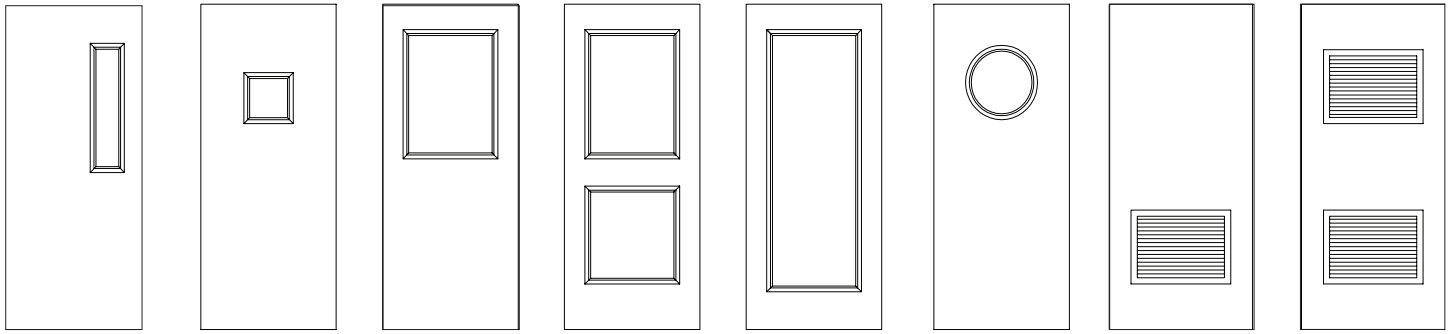

Type NL

Type G

Type HG

Type 2XHG

Type FG

Type round

Type L

Type 2XL

Door type, door size, glass type, hardware configuration all contribute to available fire rating. Please consult your Cleary/ Wholesale Doors sales team for details. When ordering metal vision panels and louvers, please make sure to specify: Top rail (top of door to top of cutout), lock stile dimension (edge of door to edge of cutout) or specify center in door width.

Hand Beaded Lites Flush Wood Bead, Lip Wood Bead & Veneered Fire Rated Bead

When ordering custom hand beaded lites, please make sure to specify:

- Cutout size (width x height)
- Top Rail (top of door to cutout)
- Lock Stile (lock edge of door to cutout) or specify center cutout in door

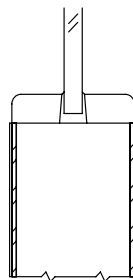

Flush bead

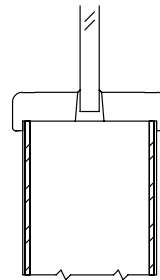

Lip bead

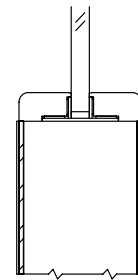

Veneered fire rated bead with metal clip system

Metal Lites And Louvers - Technical Drawings

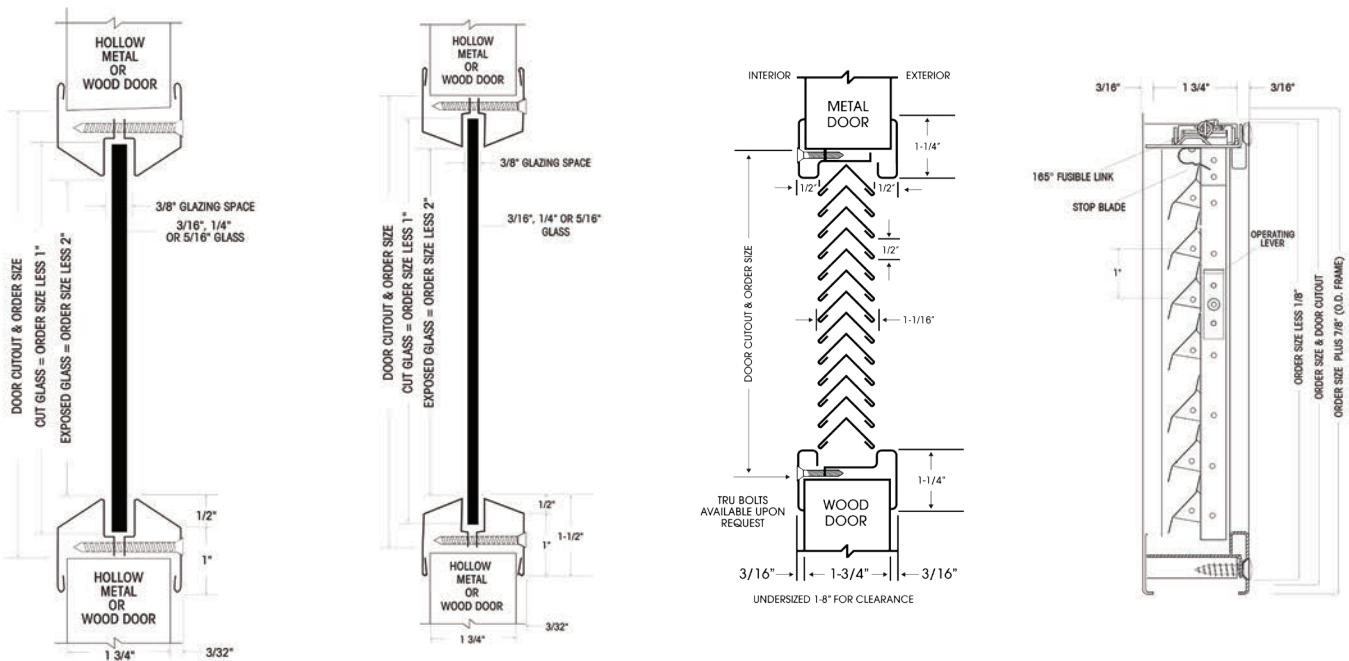

Captiva Fire-Rated Door Specifications, Jambs And Cross Sections

Captiva fire-rated wood door frames allow builders and architects to comply with the strictest building code requirements without sacrificing the design integrity of the project. A fire-resistant core is wrapped with wood veneers to perfectly match the non-rated door frames throughout the project. Captiva fire-rated door frames are available in the wood species of your choice in stain grade, paint grade and prefinished. Our frames come standard with a patented adjustable clip system for fast and simple installation.

Architectural consistency

Whether residential or commercial applications, Captiva fire-rated doors allow you to seamlessly match the Captiva non-rated doors throughout your project. Hundreds of panel door designs and many glass door designs (some restrictions on size) are available fire-rated.



Intumescent edging
Double rabbet, 90 minute, with clips
(clip removed and clips attached)

Fire-rated door specifications

- 20, 45, 60 and 90 minute door and jamb ratings
- 1-3/4" and 2-1/4" door thickness available
- Flat or rabbeted jambs
- Metal jambs available for all ratings
- All fire doors and jambs available stain grade, paint grade or prefinished
- Available with flat or raised panels
- All standard sticking and panel profile designs available
- Certified through Interek Testing Service

20 minute fire-rated door cross section

45-60-90 minute fire-rated door cross section

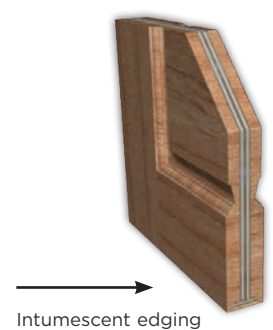

Single rabbet
60 minute



Double rabbet
60 minute



Single rabbet
90 minute



Double rabbet
90 minute



Captiva Custom Wood Doors

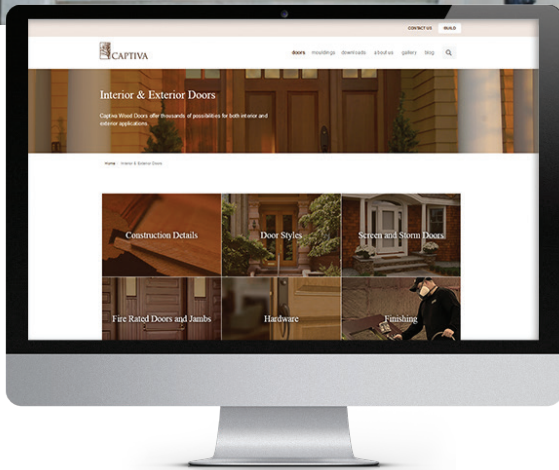

Handcrafted in New England, which is synonymous with "Old World" traditions and fine, detail-oriented architecture, Captiva Wood Doors are built to your specifications. Creating a fusion of traditional wood working techniques and technology, Captiva Wood Doors offer thousands of possibilities.

Artistic consciousness with the look and feel of quality is easy to recognize on our doors. We offer stave core construction, premium thickness, veneers, traditional stile and rail construction, and superior panel design, as well as a choice between mortise and tenon and our very own beaded tenon. All pieces are hand fit together with the industry's finest adhesives on all connections.

Captiva custom wood doors are made in Somerset, MA in our state-of-the-art manufacturing facility.

www.captivacustom.com

Explore

- Our door designs
- Prefinishing in our facility
- Commercial capabilities
- Hardware
- Construction details
- Made in the USA

Interactive spec book and Captiva catalogs available online

- Access specifications for each individual Captiva door style
- Print or save the PDF for your reference
- Download DWG files for each door style
- Download the Captiva catalog

Link to Captiva Build

- Design and quote your custom Captiva door online
- build.captivacustom.com



100's Of Designs

- Panel doors
- Glass doors
- Double doors
- Modern doors
- Dutch doors
- Transoms



8751

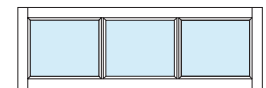

8763

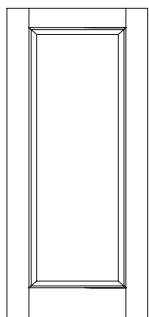

8001

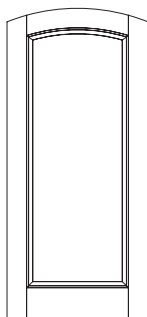

8003A

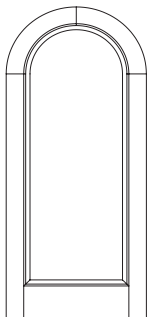

8004R

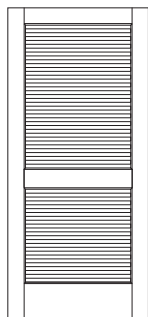

8140

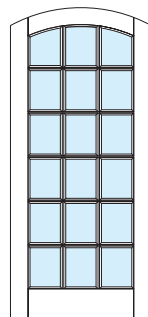

8641A

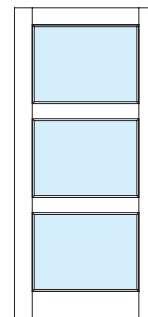

8618

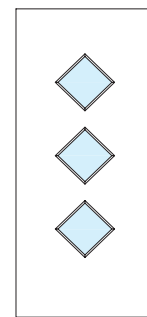

8425

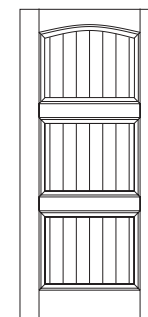

8021S/V/B

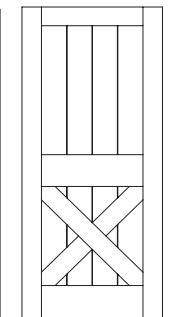

8105

Captiva MDF Doors

When it comes to the daily wear and tear of public use, trust the quality and versatility of Captiva custom mdf doors. Our expertise with all parties involved in the construction process, as well as our ability to provide the proper hardware, make Captiva custom mdf doors the perfect choice for commercial projects.

Why MDF?

Medium Density Fiberboard is an engineered wood product made from wood fibers and other recyclable materials. Denser and stronger than particle board, MDF is considered an environmentally-friendly material that is priced less than wood.

- Locally sourced
- Resists mold
- Easy to paint and holds paint finish well
- Recyclable

Why Captiva MDF?

- We source, build and ship locally, which helps minimize our carbon footprint
- We utilize a wood core which provides greater stability and allows for lighter weight than doors made with an MDF core
- We use solid wood edges so there is no need for wood wedge filler blocks
- We use solid wood mouldings for designs that use a raised moulding (like Bolection sticking) for durability
- Matching designs and profiles are available in your choice of wood species
- All door shapes and sizes are available up to 4'x10' in thickness of 1-3/8", 1-3/4", and 2-1/4"
- Matching fire-rated doors and door frames are available in 20, 45, 60, or 90-minute ratings
- A wide range of sticking and panel design options are available
- Doors are available primed or factory-painted with your choice of stock or custom colors

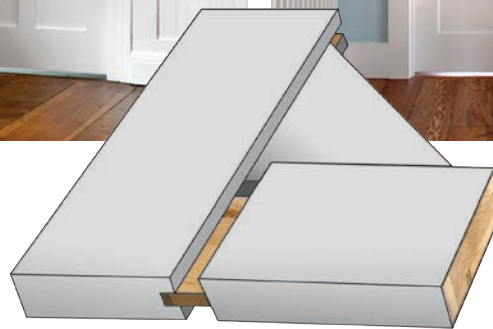

True mortise & tenon joinery
Solid wood core with MDF veneer
Solid MDF panels

Both the stiles and rails have a solid wood core to provide greater strength and stability. The MDF veneers on the stiles and rails allow for a smooth and consistent paint finish. Panels are solid MDF. Utilizing traditional mortise and tenon joinery, all pieces are hand fit together with industry's finest adhesives on all connections.

1-3/4" Solid Core Molded Doors

1 Panel Heritage Lincoln Park® flat panel 20 minute	2 Panel residential 20 minute	2 Panel Heritage Logan flat panel 20 minute	2 Panel Roman 20 minute	2 Panel Select Cheyenne® Plank 20 minute	3 Panel Livingston® 20 minute	3 Panel Heritage Winslow flat panel 20 minute	4 Panel smooth 20 minute	6 Panel residential smooth 20 minute	6 Panel commercial* smooth 20 minute

*Commercial layout utilizes larger top & bottom rails

1-3/8" Molded Hollow & Solid Core Doors

2 Panel smooth	2 Panel Roman smooth	4 Panel smooth	6 Panel smooth	2 Panel Cheyenne®
5 Panel Riverside®	3 Panel Livingston®	1 Panel Lincoln Park®	2 Panel Logan	3 Panel Winslow

1-3/8" & 1-3/4" MDF Doors

PR-C11	PR-C22	PR-C35

1-3/8" Wood Doors

Hollow core or solid core lauan, birch, or primed hardboard	1 Lite primed or clear pine	Louver & Panel primed	Full louver primed or clear pine	15 Lite primed or clear pine



FIBERGLASS DOORS

Commercial Fiberglass Doors

Doors in stock from 2/6 x 6/8 - 3/0 x 7/0.

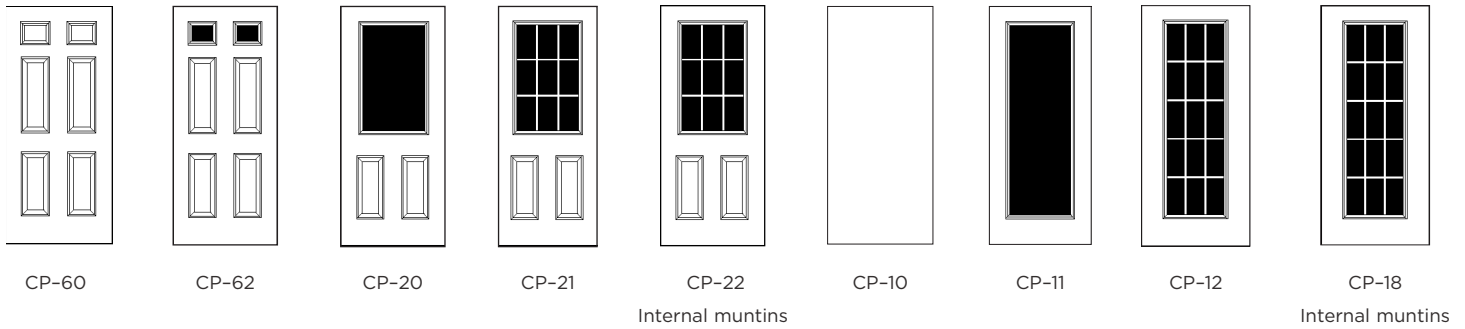

Doors available prehung or machined for De La Fontaine frame or other metal frame manufacturers.

Image shown to right:
7/0 structure with double closure block and panic bar
6/8 structure is similar, stiles are 3.175" total

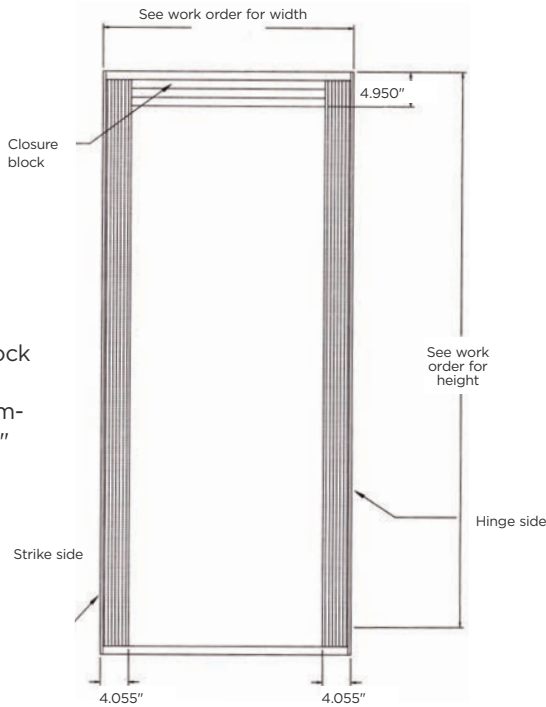

Sidelites

Align with commercial fiberglass doors above.
In stock from 1/0 x 6/8 - 1/2 x 7/0.

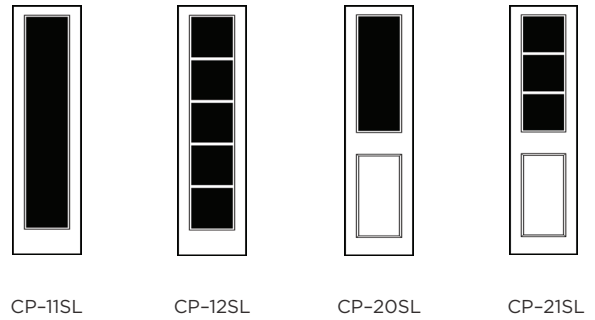

Flush Bead Glaze

In stock from 3/0 x 6/8, 3/0 x 7/0 and 3/0 x 8/0
SDL's available for flush glazed and lighthead frames

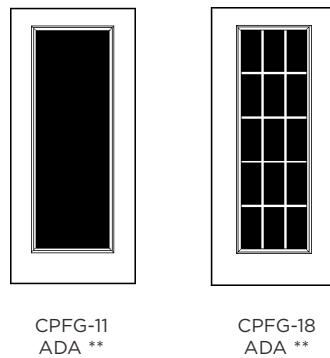

- PVC SDL's are available in a wide range of configurations. Call for pricing.
- The full view flush bead doors (CPFG-11, CPGF-18) are stocked open without glass for your choice of glass type/layout.
- 5/8" insulated glass blocked for commercial hardware

** ADA Compliant bottom rail 10-1/2"



Prehung doors available with Adaptive Sill brings an end to leaks and repairs

1. Between the base of the jamb and edge of the sill
2. At the weathertrip
3. Beneath the sill



PREFINISHING FIBERGLASS DOORS

Fortress COATING SYSTEMS™

Nothing beats the convenience and superior quality of a professionally applied factory finish. Fortress Coating Systems™ uses the latest technology to save time and provide a consistent paint quality. Fortress finishes come with a 10 year warranty.

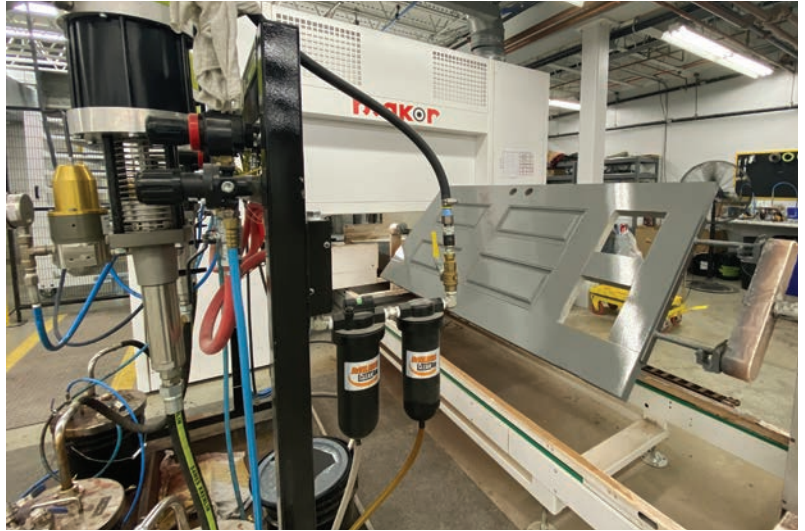

Stock Paint Colors.

Custom colors are also available. Please supply Sherwin Williams or Benjamin Moore paint number and name. Custom paint matching available with physical sample and extended lead time.

SW 2838 POLISHED MAHOGANY	SW 2848 ROYCROFT PEWTER	SW 6243 DISTANCE	SW 6244 NAVAL	SW 6258 TRICORN BLACK	SW 6454 SHAMROCK
SW 6502 LOCH BLUE	SW 6711 PARAKEET	SW 6799 SOAR	SW 6868 REAL RED	SW 6883 RAUCOUS ORANGE	SW 6902 DECISIVE YELLOW
SW 7005 PURE WHITE	SW 7048 URBANE BRONZE	SW 7510 CHATEAU BROWN	SW 7526 MAISON BLANCHE	SW 7593 RUSTIC RED	SW 7669 SUMMIT GRAY

Due to variations of printing of this catalog, or viewing on a screen, actual colors may vary. Please ask your sales rep for color sample.

Commercial Grade Hinges



Standard weight plain bearing

4-1/2" x 4-1/2"
Available in US26D



Standard weight ball bearing

4-1/2" x 4-1/2"
Available in US26D, US15, US26, US10B, US10, US4, US3, USP



Standard weight ball bearing nrp

4-1/2" x 4-1/2"
Available in US26D, US10B, US4, US3, US32D, USP

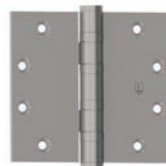

Heavy weight ball bearing

4-1/2" x 4-1/2"
Available in US26D, US32D



Half surface ball bearing

4-1/2"
Available in US26D, USP



Standard weight ball bearing

4" x 4"
Available in US26D



2 Spring 1/bb set

4-1/2" x 4-1/2"
Available in US26D, US15, US10B, US1D, US4, US3, USP

Finishes



US26D

Dull chrome



US15

Satin nickel



US26

Bright chrome



US10B

Oil rubbed bronze



US1D

Black



US10

Dull bronze



US4

Dull brass



US3

Bright brass



US32D

Satin stainless steel



USP

Primed

Continuous Hinges



- Individually cartoned with fasteners & instructions
- One hinge per door panel
- UL listed up to 90 minute door
- Standard duty for medium frequency doors up to 200 lbs
- Heavy duty for high frequency or doors over 200 lbs

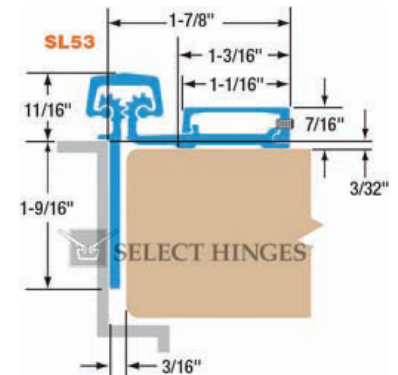
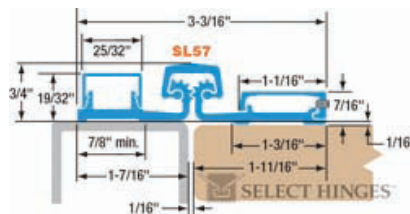
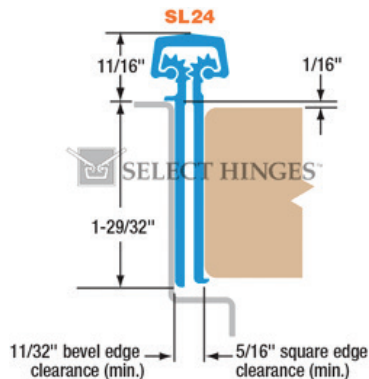
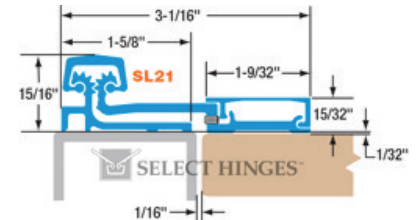
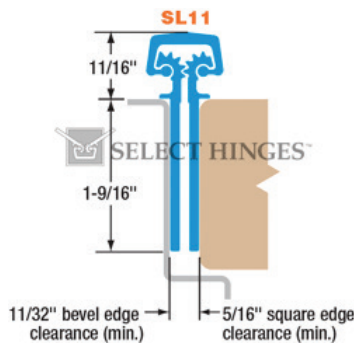

Commercial Grade Locksets



Standard duty commercial series

- Withnell lever design
- 2-3/4 Backset (2-3/8 available)
- Non-handed
- Schlage "C" keyway 6 pin cylinder - 5 pin keyed
- ASA strike
- Small format interchangeable core available
- 1 Year warranty



Extra heavy duty commercial series

- Industrial series
- Withnell lever design
- 2-3/4 Backset (2-3/8 available)
- Non-handed
- Schlage "C" keyway 6 pin cylinder - 5 pin keyed
- Small format interchangeable core available (factory quick-ship)
- ASA Strike
- Lifetime warranty



Standard duty

- Commercial series 2-3/4 backset
- Non-handed
- Schlage "C" keyway 6 pin cylinder - 5 pin keyed
- 2-3/4 deadbolt strike
- Lifetime warranty



Extra heavy duty

- Commercial series 2-3/4 backset
- Non-handed
- Schlage "C" keyway 6 pin cylinder - 5 pin keyed
- 2-3/4 deadbolt strike
- Lifetime warranty

Exit Devices

Standard duty

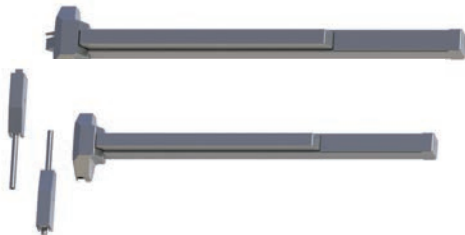

Standard duty commercial series

- Rim fire-rated device - rated up to 3 hour
- Surface vertical rod device - rated up to 1-1/2 hour
- UL10C, UL10B, UL305 listed
- Complies with ANSI 117.1
- Five year warranty



Standard duty, commercial series

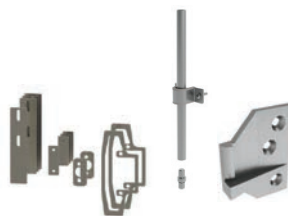

Standard duty exit device parts

- Withnell lever design
- Non-handed
- Schlage "C" Keyway 6 pin cylinder - 5 pin keyed or small format IC prep (core separate)

Heavy duty



Grade 1 heavy duty commercial series

- Fire-rated device - rated up to 3 hour
- UL10C, UL10B, UL305 listed
- Complies with ANSI 117.1
- Lifetime warranty



Grade 1 heavy duty, commercial series



Heavy duty exit device parts

- Withnell lever design
- Non-handed
- Cylinder supplied loose when requested

Locksets

NON-KEYED	FUNCTION	FUNCTION No.		FUNCTION DESCRIPTION	ANSI No.
	Passage	GRADE 1 3410	GRADE 2 2510	Latchbolt operated by lever from either side at all times	F75
	Dummy - single	GRADE 1 3417	GRADE 2 2517	Pull one side, no mechanical operation	-
	Privacy	GRADE 1 2540	GRADE 2 2540	Latchbolt operated by lever from either side. Outside lever is locked by push button inside and unlocked by emergency release outside, operating inside lever or closing door.	F76A
KEYED					
	Entry	GRADE 1 3453	GRADE 2 2553	Deadlocking latchbolt by lever either side, except when turn button inside locks outside lever. Pushing turn button in locks outside lever, requiring use of key outside to unlock. Turning inside lever unlocks outside lever. Pushing in and turning button locks outside lever, requiring key at all times. Turning inside lever does not unlock outside lever until button is manually turned to unlocked position. Inside lever always free.	F109
	Classroom	GRADE 1 3470	GRADE 2 2570	Deadlocking latchbolt operated by lever from either side except when outside lever is locked from outside by key. When outside lever is locked, latchbolt is operated by inside lever.	F84
	Storeroom	GRADE 1 3480	GRADE 2 2580	Deadlocking latchbolt operated by key in outside lever, or by operating inside lever. Outside lever is always locked. Inside lever is always unlocked.	F86
	Cylinder x Thumbturn	GRADE 1 3115	GRADE 2 3215	Deadbolt thrown or retracted by key from outside or by inside thumbturn. Bolt automatically deadlocks when fully thrown.	E2152

Flushbolts

ASSA ABLOY

ARCHITECTURAL DOOR ACCESSORIES™
Markar | McKinney | Pemko | Rockwood



Corner mount
flushbolt light duty



12" & 24"
Extension flushbolt



Corner flushbolt



Automatic flushbolt



Automatic flushbolt

Hager Door Closers

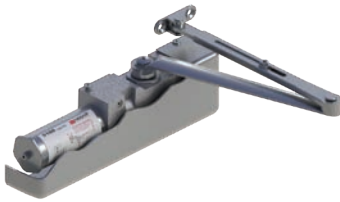

Grade 1 5100 series door closer
- painted finish

- Cast iron body
- Full plastic cover
- Adjustable sizes 1-6
- Tri-pack is regular, top jamb, parallel arm mount
- Include SNB fasteners
- Plated finishes available factory order



Grade 1 5200 series door closers
- painted finish

- Aluminum alloy body
- Slim plastic cover
- Adjustable sizes 1-6
- Tri-pack is regular, top jamb, parallel arm mount
- Extra heavy duty stop arm. Friction hold open arm in-stock
- Include SNB fasteners
- Plated finished available factory order



Grade 1 5300 series door closers
- painted finish

- Aluminum alloy body
- Full plastic cover
- Adjustable sizes 1-6
- Tri-pack is regular, top jamb, parallel arm mount
- Include SNB fasteners

Misc Flatgood / Accessories



Push plate
3-1/2" x 15"



Kick plate
8" x 30"
8" x 34"
10" x 34"



Pocket door latch



Door viewer
• UL Rated
9/16" hole
wide angle



Door stop



Chain stop
• 25-1/2"



Door bolt

ASSA ABLOY

ARCHITECTURAL DOOR ACCESSORIES™
Markar | McKinney | Pemko | Rockwood

Rescue Hardware



Double acting pivots



Double lipped strike



Mortise lockets



Interconnected lockets



Tubular locksets



Electric strike



Fob readers & systems



Emergency stop



Electric-magnetic door holders



Overhead stops / holders

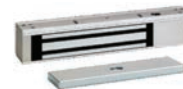

Magnetic locks



Low energy door operators

Additional Products

Weatherstripping, Sweeps And Astragals

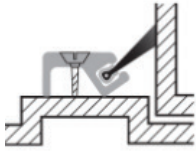

J135 Set Brush Weatherstripping

- Contains 2 jamb pcs & 1 header per set
- Stock available in aluminum.
- Special order available in dark bronze.

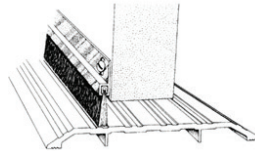

C380 Door sweep

- Stock available in aluminum.
- Special order available in dark bronze

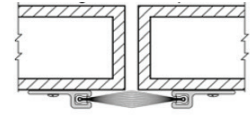

C380 Astragal sets

- Stock available in aluminum.
- Special order available in dark bronze

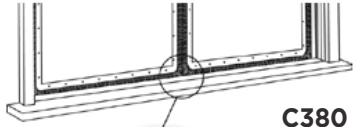

C380 Astrasweep Set

- Contains 2 astragals, 2 sweeps and 2 corner pcs per set
- Stock available in aluminum.
- Special order available in dark bronze

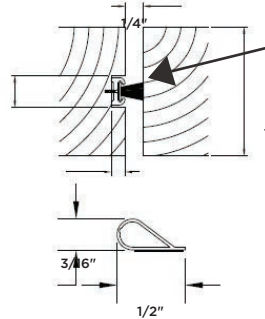

NGP 136P Mortised Astragal:

Gray pile, aluminum retainer. Can be installed in wood or fiberglass doors.

- Smoke seals - PEMKO S88 adhesive mount silicone bulb
- Stock available in black.
- Special order available in clear, dark bronze, gray, tan & white

DS075 Heavy Duty (low profile) Door Weathrestripping

- Construction Extruded aluminum. Mitred corners ensure a secure fit with slotted mounting holes for easy adjustment.
- Finish: Aluminum, brown or white finish
- Insert: 1/4" flexible, bubble type neoprene or vinyl insert
- Set: 1-3' piece and 2-7' pieces, custom lengths also available

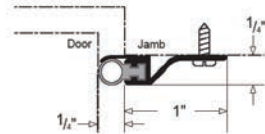

HS051 - Heavy Duty Door Sweep

- Construction Extruded aluminum
- Insert: 3/4" neoprene insert
- Finish: Aluminum or brown finish
- Lengths: 36", 42" or 48" or by the linear foot

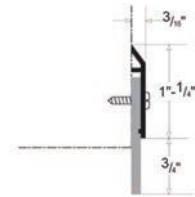

Sills



Aluminum Sills - 1/4" Tall - Mill Aluminum Finish

Available in 36", 48" & 72"

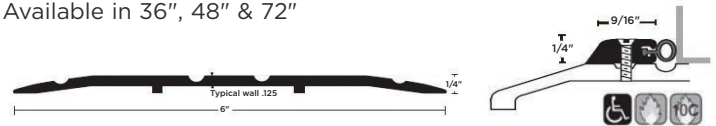

Aluminum Sills - 1/2" Tall - Mill Aluminum Finish

Available in 36" to 120"



AT-600 - 5" flat threshold, 1/2" rise



AT-601 - 6" flat threshold, 1/2" rise



AT-599 - 5" panic threshold
7/8" rise
Available inserts: vinyl, bubble
Gray or Black
Brush Fin-seal



AT-700 - 7" flat threshold, 1/2" rise



AT-800 - 8" flat threshold, 1/2" rise

Medium Duty Aluminum Sills

Stock available in black.
Special order available in clear, dark bronze, gray, tan & white



Aluminum Sills - 1/2" Tall - Thermal Break - Mill Aluminum Finish

Available in 36", 48" & 72"

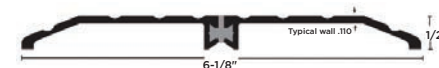

Cendrex Access Panels



AHD
All purpose
Non-rated

The AHD is designed for a quick and easy installation on non-rated vertical and horizontal surfaces made of dry-wall or any other type of material.



PFN
Fire-rated 1-1/2 Hour

The PFN access door is not insulated and can only be used on fire rated walls. It comes with a 1" flange for an easy flush installation on any type of surface material.

PFN fire rated panels are for wall mount ONLY.

Optional accessories for Cendrex access panels

Available by Special Order

Mortise locks for fire rated access panels must be factory installed.
Stainless steel is available by special order.

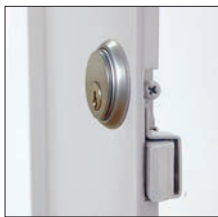

Mortise cam latch
cylinder optional



Mortise cam latch
cylinder optional

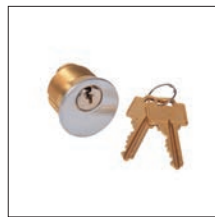

Cylinder for deadbolt
or mortise lock



Mortise deadbolt



Screwdriver cam latch



Inside release
thumbturn for mortise
deadbolt

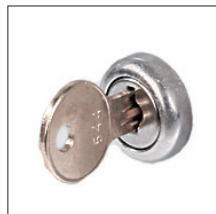

Key operated
cam latch



Gasket



Slam latch

Johnson 1500 Commercial Grade Pocket Door Frame

TESTED QUALITY – Johnson pocket door frames are the only pocket door frames independently tested to ANSI standards. All frames can be cut down to accommodate any small size door.

Easily assembled, structurally strong pocket door frame designed for fast installation in standard 2 x 4 timber or steel frame stud walls typically sheeted with drywall. Versatile frame can be adapted for use in thicker walls or cut down to accept any smaller size door. Removable aluminum track with low friction convex track rails, guaranteed jump proof smooth rolling tricycle hangers, rust resistant zinc plated steel reinforced timber split studs and self adjusting floor anchors.

DESCRIPTION	
PFR	Standard duty pocket door frame 3/0 x 6/8 - max door weight 125 lbs
PFR7HD	Heavy duty pocket door frame 3/0 x 7/0 with 1125 ball bearing rollers - max door weight 200 lbs
PFR8HD	Heavy duty pocket door frame 3/0 x 8/0 with 1125 ball bearing rollers - max door weight 200 lbs
PFR408HD	Heavy duty pocket door frame 4/0 x 8/0 with 1125 ball bearing rollers - max door weight 200 lbs
PCR408HD	1-3/4" Door adaptor kit
JH	Converging door kit
PFRSCKIT	Pocket door soft closing kit



Johnson Bifold / Bypass Hardware

In stock from 3/0 to 8/0 widths

Heavy duty Johnson 110FD series

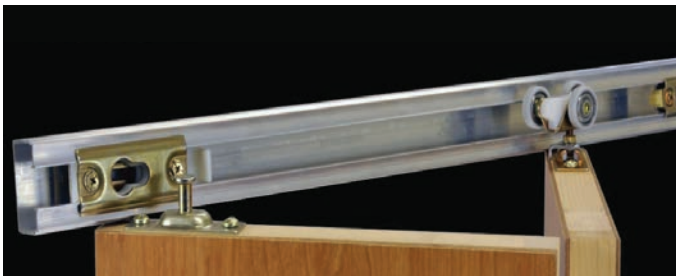

Finished opening requirements:

- 2 Leaf set
- Add: 9/16" total combined door width
- Add: 2-7/8" to net door height
- 4 Leaf set
- Add: 15/16" total combined door width
- Add: 2-7/8" to net door height

Maximum panel width: 24"

Maximum panel height: 108"

Top mount hanger type, commercial grade

Bypass slider hardware



Finished opening requirements:

- 2 Leaf set
- Deduct: 1" total combined door width
- Add: 2-3/8" to net door height
- 3 Leaf set
- Deduct: 2" total combined door width
- Add: 2-3/8" to net door height

Heavy duty Johnson 138F series for 1-3/8" or 134F series for 1-3/4"

Maximum track length 16'

Top mount hanger type, commercial grade

Captiva MDF barn doors

K STYLE



PRIMED MDF
V-GROOVE
36" x 84" x 1-3/8"
(ideal for openings 28" - 34")

1 PANEL



PRIMED MDF
V-GROOVE
36" x 84" x 1-3/8"
(ideal for openings 28" - 34")

2 PANEL



PRIMED MDF
V-GROOVE
36" x 84" x 1-3/8"
(ideal for openings 28" - 34")

Barn door hardware

Available in matte black and stainless steel. Size 78-3/4" or 96"

Kits include:

- 78-3/4" kits - 5 wall spacers and mounting screws / bolts
- 96" kits include 6 wall spacers and mounting screws / bolts
- Black finished bolts are used for both bronze & matte black applications
NOTE: Bolts for 1-3/8" and 1-3/4" doors are included in all standard kits
- For use with 1-3/8" and 1-3/4" solid core flush, solid core molded and wood doors
- For single door openings up to 36". Double door applications require 2 kits
- Solid wood blocking required for drywall installation (wood and mounting screws not included)
- Kit contains everything needed for concrete wall application
- Max weight 250 lbs

Barn door easy clip single soft close kit

Available in matte black only



Bent strap
matte black



Straight strap
matte black



Top of door strap
stainless steel



Soft close kit

See residential catalog for complete offering of barn door kits and hardware.

Hadrian Toilet Partitions



Headrail braced toilet partitions

Stock colors: light grey

- Pilasters in stock 3'-23'
 - Panels in stock from 14" W-70" W x 58" H
 - Door sizes from 23"-26" H
- Stainless steel and solid plastic available- Factory order

Powder coated solid color



Powdercoated anti graffiti

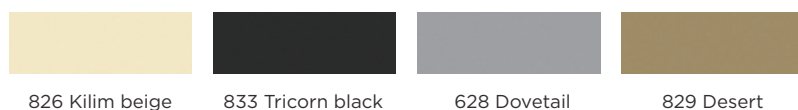

Powdercoated special effects

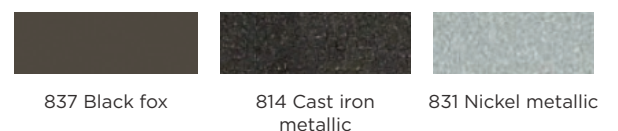

ASI Washroom Accessories



Roll paper towel holder



Paper towel dispenser



Paper towel dispenser/disposal 2 gallon



Paper towel dispenser/disposal 13 gallon



Dual napkin disposal partition mount



Sanitary napkin disposal



Dual toilet tissue dispenser



Single toilet tissue holder



Double toilet tissue holder



Single toilet tissue holder



Double toilet tissue holder



Single toilet tissue holder



Double toilet tissue holder



Liquid soap dispenser



Waste receptacle 7 gallon



Dual napkin / tampon dispenser



Horizontal liquid soap dispenser



Vertical liquid soap dispenser



Counter mount all purpose soap dispenser



Single robe hook



Double robe hook



Handicap tilt frame mirror



Channel frame mirror



Adjustable tilt frame mirror

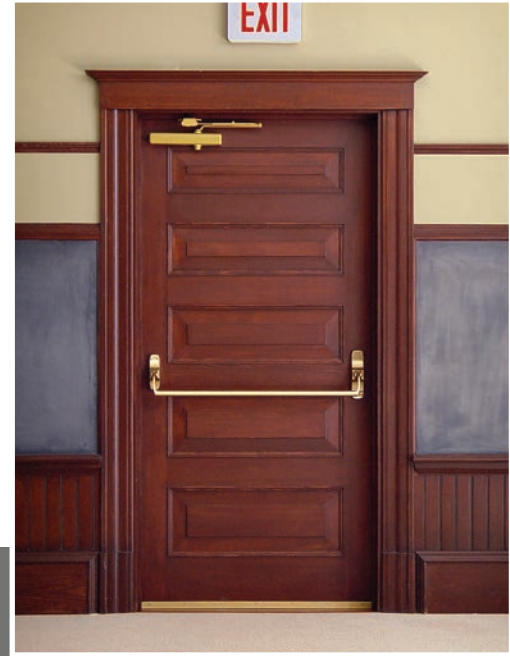

Wholesale Doors
COMMERCIAL DIVISION

1255B Grand Army Highway | Somerset, MA 02726
Phone 800-899-4533

2049 Silas Deane Highway, Suite 1A
Rocky Hill, CT 06067
Phone 800-486-7600

120 Defreest Drive, Suite 19
(Rensselaer Technology Park) Troy, NY 12180
Phone 800-350-0448

Wholesale Doors (Sales Office)

220 Green Forbes Road, Suite 403 | Braintree, MA 02471
Phone 617-923-9700

For Quotes : quotes@wdiinc.com
For Orders : orders@wdiinc.com
For General Inquiries : support@clearymillwork.com

www.ClearyMillwork.com    

MASONITE At Cleary Millwork
our goal is to provide you with the products, services, training, and support to enable you to successfully establish your company as a competitive source for custom windows, commercial products as well as commodity network lines.

REGAL VALLEY DOOR
Cleary's capabilities are far superior to any other New England supplier in pre-manufactured doors and windows, custom windows and doors, commercial hollow metal and custom hardware. For more information visit our website www.clearymillwork.com.

CAPTIVA
RESIDENTIAL PRODUCT OFFERING
Scholar Doors
Captiva Custom wood of
Massachusetts
Pine & security doors
Ridge Veneer wood door
Patio doors
Partitions for doors and
windows
Impact Doors
Massive interior window
wood doors
Captiva VDF doors
Captiva custom wood of
Massachusetts
Partitions and fire
rated ceiling systems
Windows
Hollow windows and doors
Partitions
Quote requests / questions
support@wdiinc.com

DE LA PONTAINE
WHOLESALE DOORS, COMMERCIAL DIVISION
Wholesale distributor of commercial & architectural wood doors,
hollow metal doors and frames, fire rating units, hardware and built partitions.

COMMERCIAL PRODUCT OFFERING
Architectural and Commercial Grade Wood Doors
Storm-Resistant Entry
Massachusetts Architectural
Fire Rated
Steel and Fiberglass Doors
De La Pontaine
Partitions commercial strength
Hollow Metal Doors and Frames
Hollow Metal Entry
Weather-Stripped Frames
Custom Wood Door and Frames
Captiva custom wood of MA & CT doors
Captiva fire rated doors
Captiva fire rated wood frames (any species, any size)

plastro
Commercial Hardware
Hinge Wedges & Hardware
Ball-Stop
Ball-Stop
Door-Set Architectural Hardware
National Guard Products

HAGER
Partitions, Toler Partitions and Built Accessories
Curtain Access Panels
Hollow Metal Partitions
All built accessories

ASI
Quote requests / questions
support@wdiinc.com

hadrian
Quote requests / questions
support@wdiinc.com

SDFRAME
Quote requests / questions
support@wdiinc.com

Cleary MILLWORK
1255B Grand Army Highway | Somerset, MA 02726
Phone 800-899-4533
www.clearymillwork.com

Cleary MILLWORK
2049 Silas Deane Highway, Suite 1A
Rocky Hill, CT 06067
Phone 800-486-7600
www.clearymillwork.com

Cleary MILLWORK
120 Defreest Drive, Suite 19
(Rensselaer Technology Park) Troy, NY 12180
Phone 800-350-0448
www.clearymillwork.com

Download our line card at www.ClearyMillwork.com